

# L'EXCELLENCE DE L'INOX



INOX L'EXCELLENCE DE L'INOX L'EXO

CONCEPTEUR ET FABRICANT D'EQUIPEMENT EN INOX

47 route des Aix  
18220 RIANS

Tél : 02 48 64 85 77  
Fax : 02 48 64 87 56

JANVIER 2020



# Bloc Pickings Vertical Simple



Réf.	Désignation	Larg	Prof	Haut	Prix H.T.
ACCR 12-02-00	Bloc picking - 2 logements larg 130	130	314	270	174 €
ACCR 12-03-00	Bloc picking - 3 logements larg 130	130	314	405	214 €
ACCR 12-04-00	Bloc picking - 4 logements larg 130	130	314	540	248 €
ACCR 12-05-00	Bloc picking - 5 logements larg 130	130	314	675	291 €
ACCR 12-06-00	Bloc picking - 6 logements larg 130	130	314	810	325 €

\*Autres dimension(s) et conception(s) possibles





# Bloc Pickings Vertical Double

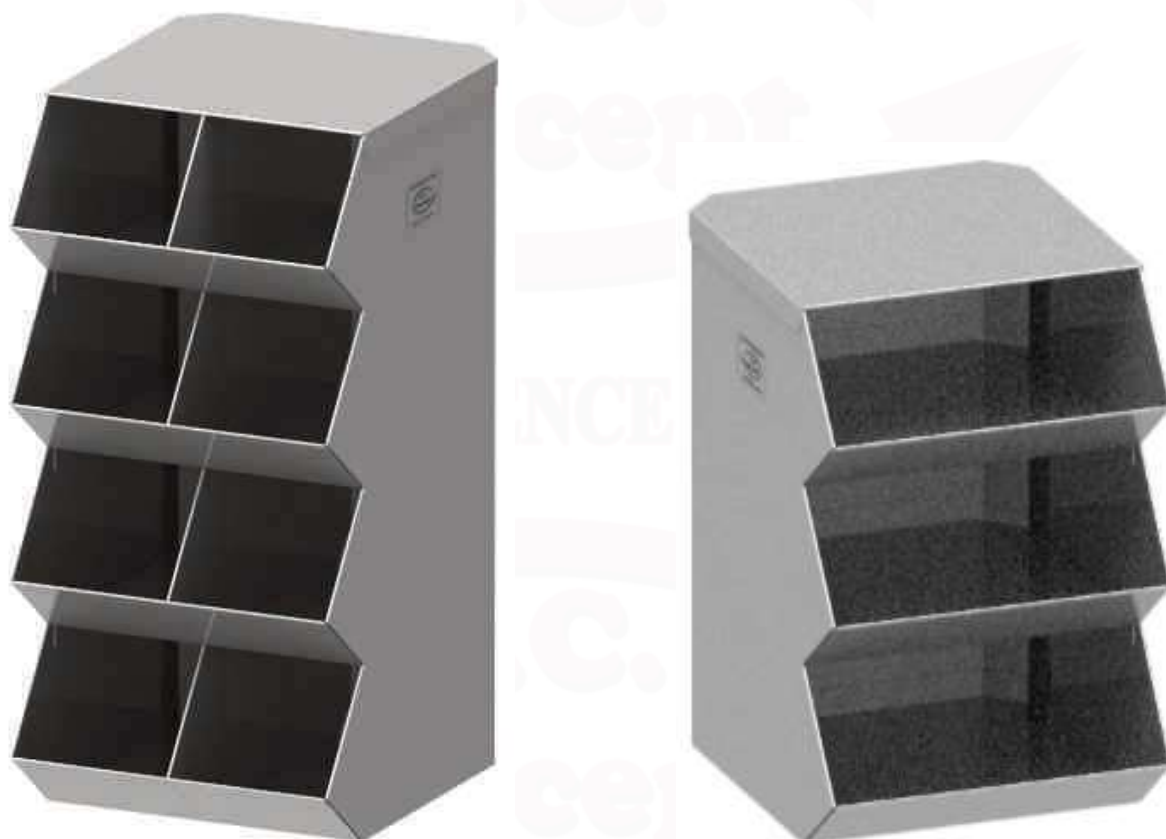

Réf.	Désignation	Larg	Prof	Haut	Prix H.T.
ACCR 13-02-00	Bloc picking - 4 logements larg 260	260	314	270	207 €
ACCR 13-03-00	Bloc picking - 6 logements larg 260	260	314	405	267 €
ACCR 13-04-00	Bloc picking - 8 logements larg 260	260	314	540	316 €
ACCR 13-05-00	Bloc picking - 10 logements larg 260	260	314	675	372 €
ACCR 13-06-00	Bloc picking - 12 logements larg 260	260	314	810	426 €

\*Autres dimension(s) et conception(s) possibles





# Bloc Pickings Horizontal

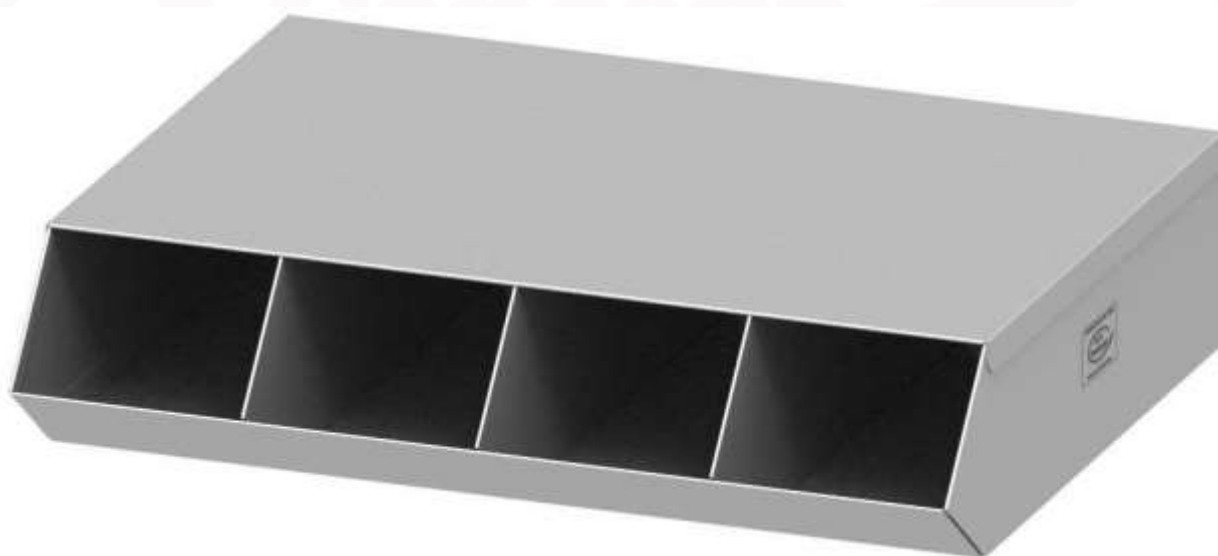

Réf.	Désignation	Larg	Prof	Haut	Prix H.T.
ACCR 14-03-00	Bloc picking Simple 1 étage 3 logements	422	442	128	219 €
ACCR 14-04-00	Bloc picking Simple 1 étage 4 logements	561	442	128	262 €
ACCR 14-05-00	Bloc picking Simple 1 étage 5 logements	701	442	128	306 €
ACCR 14-06-00	Bloc picking Simple 1 étage 6 logements	840	442	128	426 €

\*Autres dimension(s) et conception(s) possibles





# Bloc de Rangement

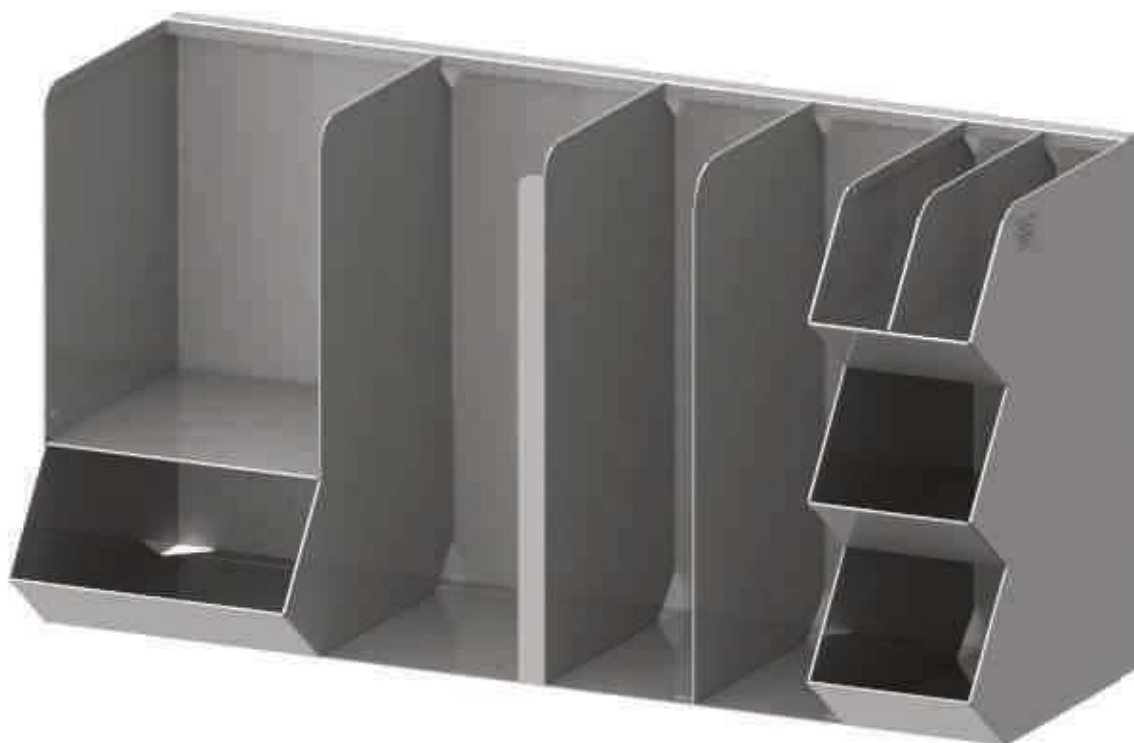

Réf.	Désignation	Larg	Prof	Haut	Prix H.T.
-	Bloc de Rangement	780	292	409	546 €





# Tiroir Amovibles



Réf.	Désignation	Larg	Prof	Haut	Prix H.T.
ACCR 06-01-00	Tiroir Amovibles Simple	218	114	302	84 €
ACCR 06-11-00	Tiroir Amovibles Double	218	221	302	152 €
ACCR 06-21-00	Tiroir Amovibles Large	338	411	114	114 €

\*Autres dimension(s) et conception(s) possibles





# Tablette Rabattable

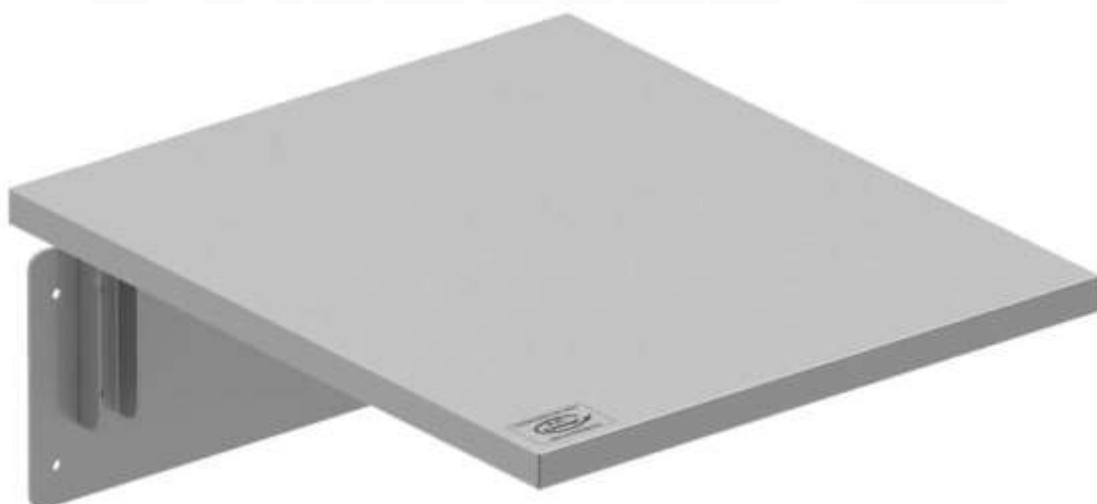

Réf.	Désignation	Larg	Prof	Haut	Prix H.T.
-	Tablette Rabattable (Sur-Mesure)	-	-	-	-

\*Autres dimension(s) et conception(s) possibles





# Support Papiers Gras



Réf.	Désignation	Larg	Prof	Haut	Prix H.T.
-	Support Papiers Gras	310	380	405	469 €

\*Autres dimension(s) et conception(s) possibles







# Tablette Ketchup / Moutarde

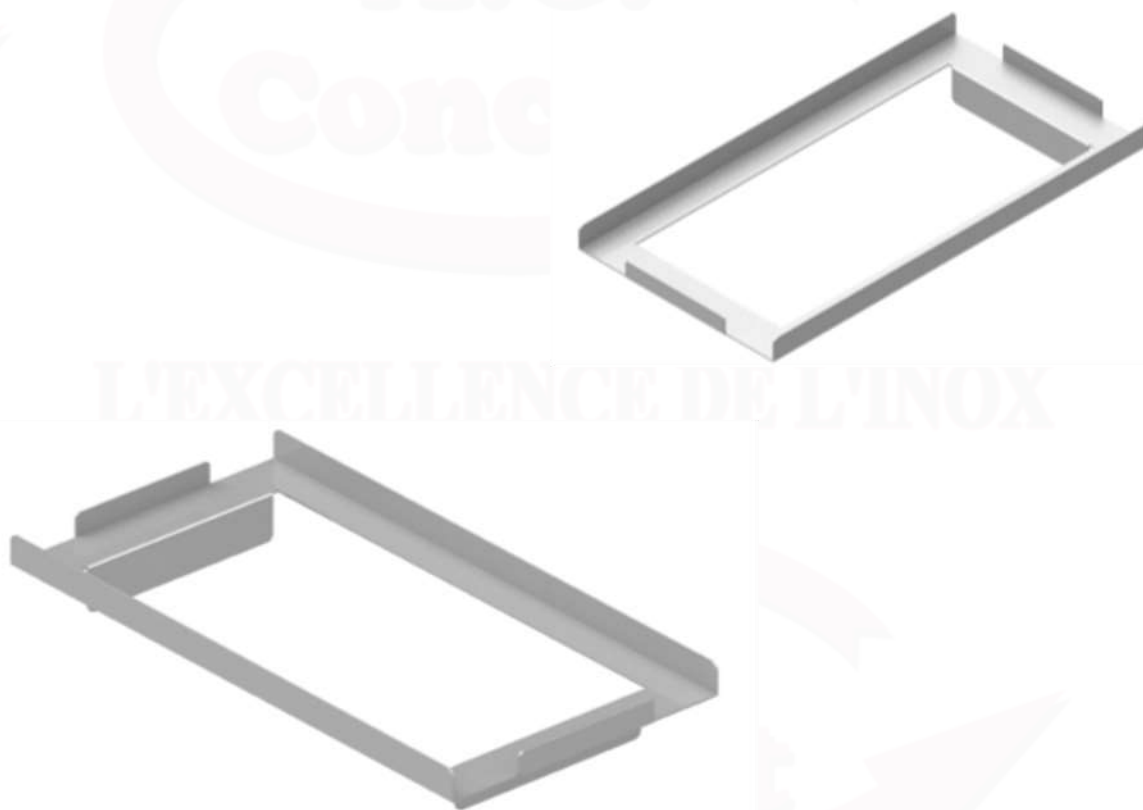

Réf.	Désignation	Larg	Prof	Haut	Prix H.T.
-	Support Ketchup / Moutarde	205	400	302	69 €

\*Autres dimension(s) et conception(s) possibles





# Chariot Réassort



Réf.	Désignation	Larg	Prof	Haut	Prix H.T.
ACCR 08-01-00	Chariot de Réassortiment Panneaux Grillagé	1028	612	776	572 €

\*Autres dimension(s) et conception(s) possibles





# Chariot Bacs Gerbables



Réf.	Désignation	Larg	Prof	Haut	Prix H.T.
ACCR 09-01-00	Chariot pour Bacs Gerbables	470	620	1184	483 €

\*Autres dimension(s) et conception(s) possibles





# Chariot Stockeur Plateaux



Réf.	Désignation	Larg	Prof	Haut	Prix H.T.
ACCR 11-01-01	Chariot Stockeur de Plateaux	324	555	394	249 €
ACCR 11-11-01	Chariot Stockeur de Plateaux + Poignée	324	570	900	318 €
ACCR 11-21-00	Poignée Chariot Stockeur de Plateaux	310	25	788	74 €

\*Autres dimension(s) et conception(s) possibles





# Chariot à Seaux



Réf.	Désignation	Larg	Prof	Haut	Prix H.T.
ACCR 07-02-00	Chariot à seaux 2 emplacements	356	726	849	290 €
ACCR 07-03-00	Chariot à seaux 3 emplacements	356	1066	849	315 €

\*Autres dimension(s) et conception(s) possibles





# Table d'Encaissement



Réf.	Désignation	Larg	Prof	Haut	Prix H.T.
ACCR 27-02-00	Table d'encaissement - Simple	563	603	~ 940	588 €
ACCR 28-02-00	Table d'encaissement - Double	1103	603	~ 940	719 €

\*Autres dimension(s) et conception(s) possibles





# Support Squeeze Bottle

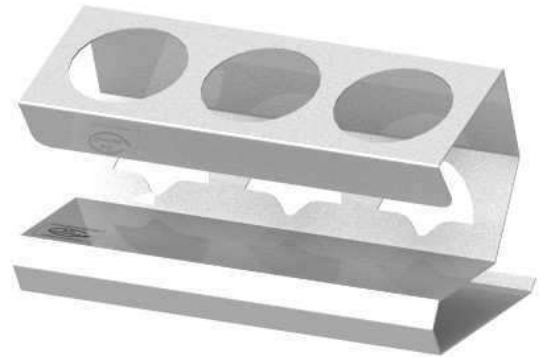

Réf.	Désignation	Larg	Prof	Haut	Prix H.T.
-	Support Squeeze Bottle Ø75 à fixer – 3 Trous	285	100	103	71 €
-	Support Squeeze Bottle Ø75 à fixer – 4 Trous	375	100	103	74 €
-	Support Squeeze Bottle Ø75 à poser – 3 Trous	285	149	158	98 €
-	Support Squeeze Bottle Ø75 à poser – 4 Trous	375	149	158	113 €

\*Autres dimension(s) et conception(s) possibles





# Support Bac Gastro

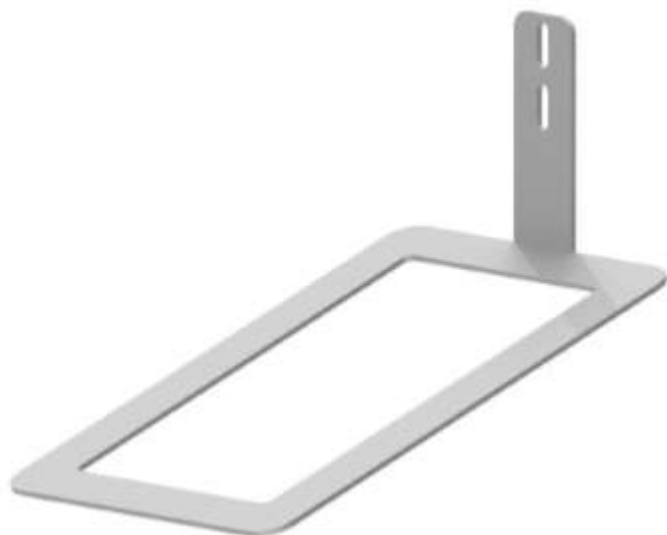

Réf.	Désignation	Larg	Prof	Haut	Prix H.T.
-	Support Bac Gastro Suspendu	128	181	142	29 €

\*Autres dimension(s) et conception(s) possibles







# Tablette Hors Sol



Réf.	Désignation	Larg	Prof	Haut	Prix H.T.
--	Tablette Hors Sol	303	253	146	118 €

\*Autres dimension(s) et conception(s) possibles





# Ergonomie Comptoir



Réf.	Désignation	Larg	Prof	Haut	Prix H.T.
-	Chariot Comptoir Bornes L1240	1240	487	860	1321 €
-	Chariot Comptoir Bornes L1430	1430	487	860	1385 €
-	Chariot Comptoir Bornes L1010	1010	487	860	1281 €

\*Autres dimension(s) et conception(s) possibles





# Ergonomie Comptoir

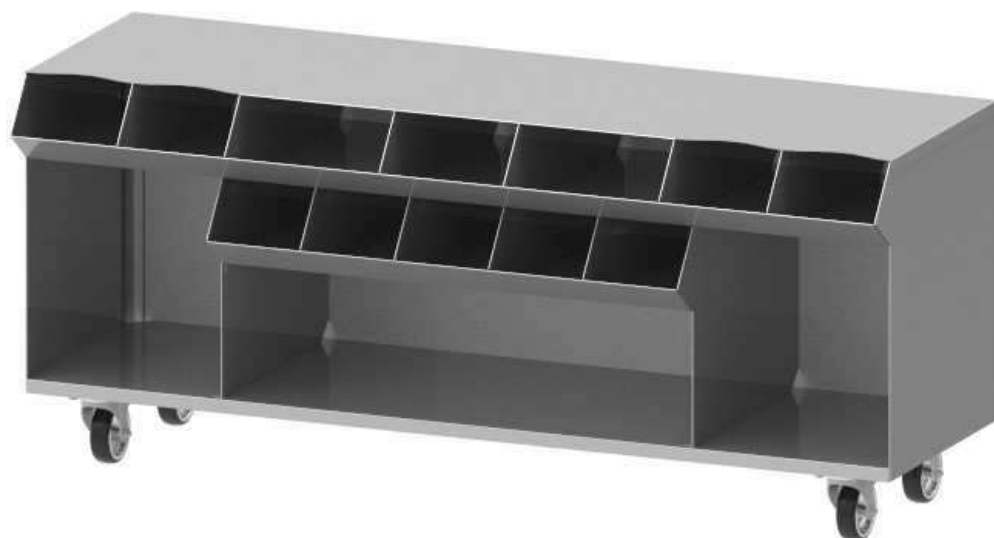

Réf.	Désignation	Larg	Prof	Haut	Prix H.T.
-	Chariot Comptoir L1460	1460	487	640	1267 €
-	Chariot Comptoir L700	700	487	640	828 €
-	Chariot Comptoir L1240	1240	487	640	1146 €

\*Autres dimension(s) et conception(s) possibles





# Table à Boissons



Réf.	Désignation	Larg	Prof	Haut	Prix H.T.
-	Table à Boissons (Sur-Mesure)	-	-	-	-

\*Autres dimension(s) et conception(s) possibles





# Support Boite Menu Menu Enfant

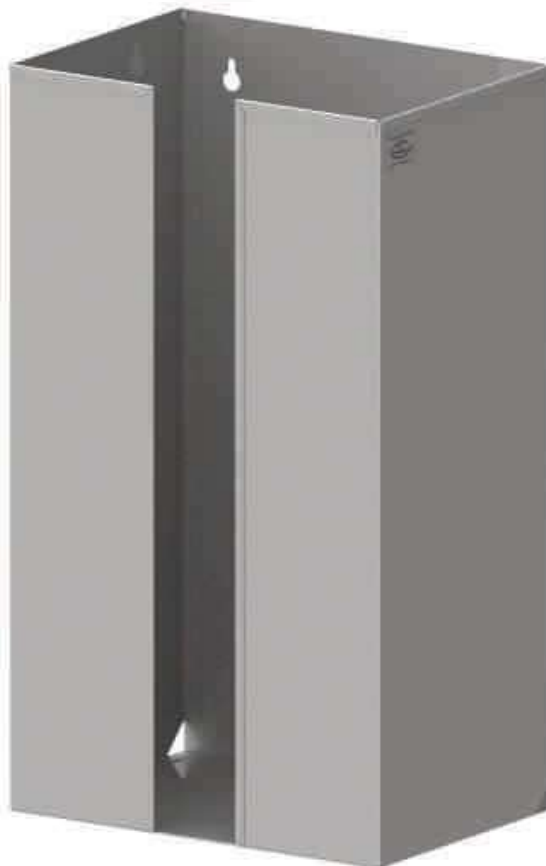

Réf.	Désignation	Larg	Prof	Haut	Prix H.T.
-	Chariot Boite Menu Enfant	505	325	800	353 €
-	Support Mural Boite Menu Enfant	470	325	805	282 €

\*Autres dimension(s) et conception(s) possibles





# Support Imprimante



Réf.	Désignation	Larg	Prof	Haut	Prix H.T.
-	Support Imprimante Fixation Droite	155	217	173	54 €
-	Support Imprimante Fixation Gauche	155	217	173	54 €

\*Autres dimension(s) et conception(s) possibles





# Ergonomie Drive



Réf.	Désignation	Larg	Prof	Haut
-	Ergonomie Drive (Sur-Mesure)	-	-	-

\*Autres dimension(s) et conception(s) possibles





# Ergonomie Drive



Réf.	Désignation	Larg	Prof	Haut
-	Ergonomie Drive (Sur-Mesure)	-	-	-

\*Autres dimension(s) et conception(s) possibles







# Ergonomie Drive



Réf.	Désignation	Larg	Prof	Haut
-	Ergonomie Drive (Sur-Mesure)	-	-	-

\*Autres dimension(s) et conception(s) possibles





# Ergonomie Drive



Réf.	Désignation	Larg	Prof	Haut
-	Ergonomie Drive (Sur-Mesure)	-	-	-

\*Autres dimension(s) et conception(s) possibles





# Elévation Table



Réf.	Désignation	Larg	Prof	Haut
-	Elévation Table (Sur-Mesure)	-	-	-

\*Autres dimension(s) et conception(s) possibles





# Rampe Couvercle

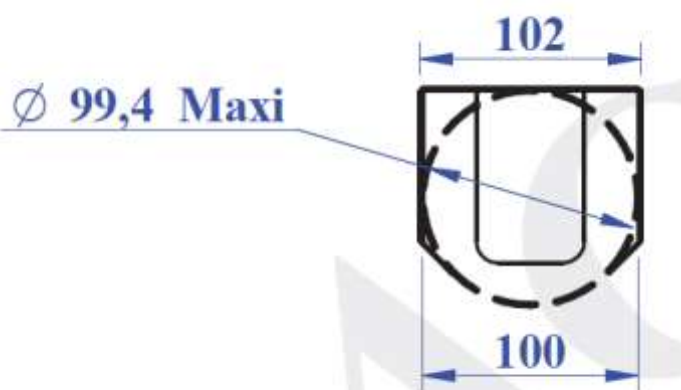

Réf.	Désignation	Larg	Prof	Haut	Prix H.T.
-	Rampe pour Couvercle de Gobelets	102	86	650	51 €

\*Autres dimension(s) et conception(s) possibles





# Support Sac Dessous Table



Réf.	Désignation	Larg	Prof	Haut	Prix H.T.
ACCR 05-01-00	Support Sac pour Dessous de Table	63	53	50	13 €

\*Autres dimension(s) et conception(s) possibles





# Arbre à Ballons

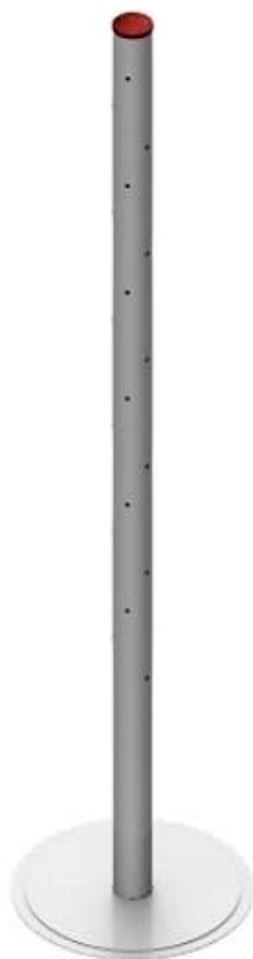

Réf.	Désignation	Larg	Prof	Haut	Prix H.T.
ACCR 03-01-00	Arbre à Ballons	450	450	1960	394 €

\*Autres dimension(s) et conception(s) possibles





# Habillage Extincteur



Réf.	Désignation	Larg	Prof	Haut	Prix H.T.
ACCR 02-01-00	Habillage d'extincteur aluminium	730	315	220	142 €

\*Autres dimension(s) et conception(s) possibles





# Potelet de Guidage



Réf.	Désignation	Larg	Prof	Haut	Prix H.T.
ACCR 39-01-00	Bloc picking - 2 logements larg 130	130	314	270	239 €

\*Autres dimension(s) et conception(s) possibles







# Présentation à Journaux



Réf.	Désignation	Larg	Prof	Haut	Prix H.T.
ACCR 41-01-00	Présentoir à Journaux	574	450	1340	426 €

\*Autres dimension(s) et conception(s) possibles





# Protège Bouton



Réf.	Désignation	Larg	Prof	Haut	Prix H.T.
ACCR 01-01-00	Protège bouton "Schneider" simple	100	75	70	52 €
ACCR 01-02-00	Protège bouton "Schneider" double	100	75	140	67 €
ACCR 01-11-00	Protège bouton "Eaton" simple	100	80	85	52 €
ACCR 01-12-00	Protège bouton "Eaton" double	100	80	170	67 €

\*Autres dimension(s) et conception(s) possibles





# Desserte machine à glaçons



Réf.	Désignation	Larg	Prof	Haut	Prix H.T.
-	Plateau Roulant	600	800	198	306 €

\*Autres dimension(s) et conception(s) possibles





Réf.	Désignation	Larg	Prof	Haut	Prix H.T.
-	Rayonnage (Sur-Mesure)	-	-	-	-

\*Autres dimension(s) et conception(s) possibles

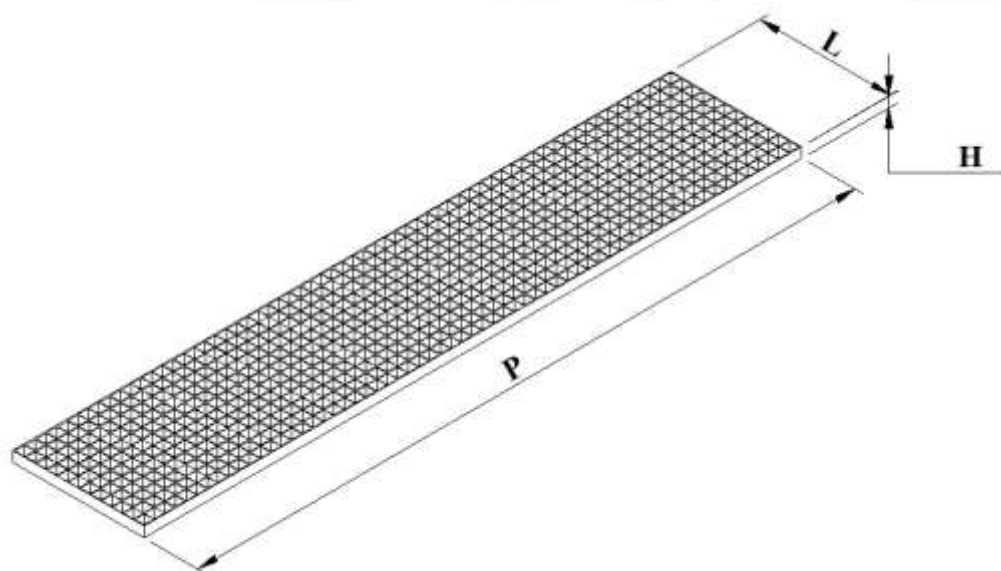

Réf.	Désignation	Larg	Prof	Haut	Prix H.T.
ACCR 10-01-00	Caillebotis Pressé Cranté SR4	990	295	25	104 €
ACCR 10-02-00	Caillebotis Pressé Cranté SR4	990	195	25	88 €
ACCR 10-03-00	Caillebotis Pressé Cranté SR4	1120	195	25	112 €
ACCR 10-04-00	Caillebotis Pressé Cranté SR4	990	140	25	80 €

\*Autres dimension(s) et conception(s) possibles



# Seuil & Rampe

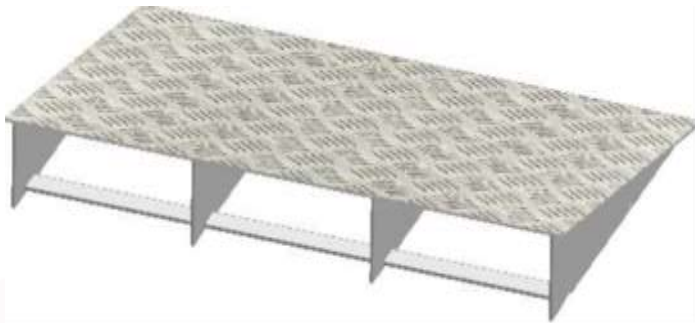

Réf.	Désignation	Larg	Prof	Haut	Prix H.T.
-	Seuil de porte (Sur-Mesure)	-	-	-	-
-	Rampe (Sur-Mesure)	-	-	-	-

\*Autres dimension(s) et conception(s) possibles





# Bouchon pour Siphon de Cuisine



Réf.	Désignation	Larg	Prof	Haut	Prix H.T.
-	Bouchon pour Siphon Cuisine (Sur-Mesure)	-	-	-	-
-	Grille (Sur-Mesure)	-	-	-	-
-	Cône d'évacuation (Sur-Mesure)	-	-	-	-

\*Autres dimension(s) et conception(s) possibles





# Sabot de Protection



Réf.	Désignation	Larg	Prof	Haut	Prix H.T.
-	Sabot de Protection	110	110	200	33 €

\*Autres dimension(s) et conception(s) possibles







## Notre bureau d'étude

Assure notre expertise technique.

Conduit tous les calculs théoriques.

Maîtrise notre logiciel de C.A.O. 3D pour plus de rapidité dans la conception.

Propose la simulation des solutions proposées avec des mises en situations théoriques.

## Fabrication

Notre atelier garanti une production soignée pour une pièce unique comme pour une série.  
Il s'appuie sur des outils de production récents et performants.

## Livraison, Chantier et Suivi

Nos techniciens peuvent gérer la livraison et la mise en fonction de nos solutions.

Notre service commercial assure une présence permanente chez nos clients pour une meilleure réactivité

## Maintenance

Notre structure nous permet de mettre en place un large panel d'interventions sur site :

- Remplacement de matériel
- Réparations ( Travaux de soudure,...)



# Contacts

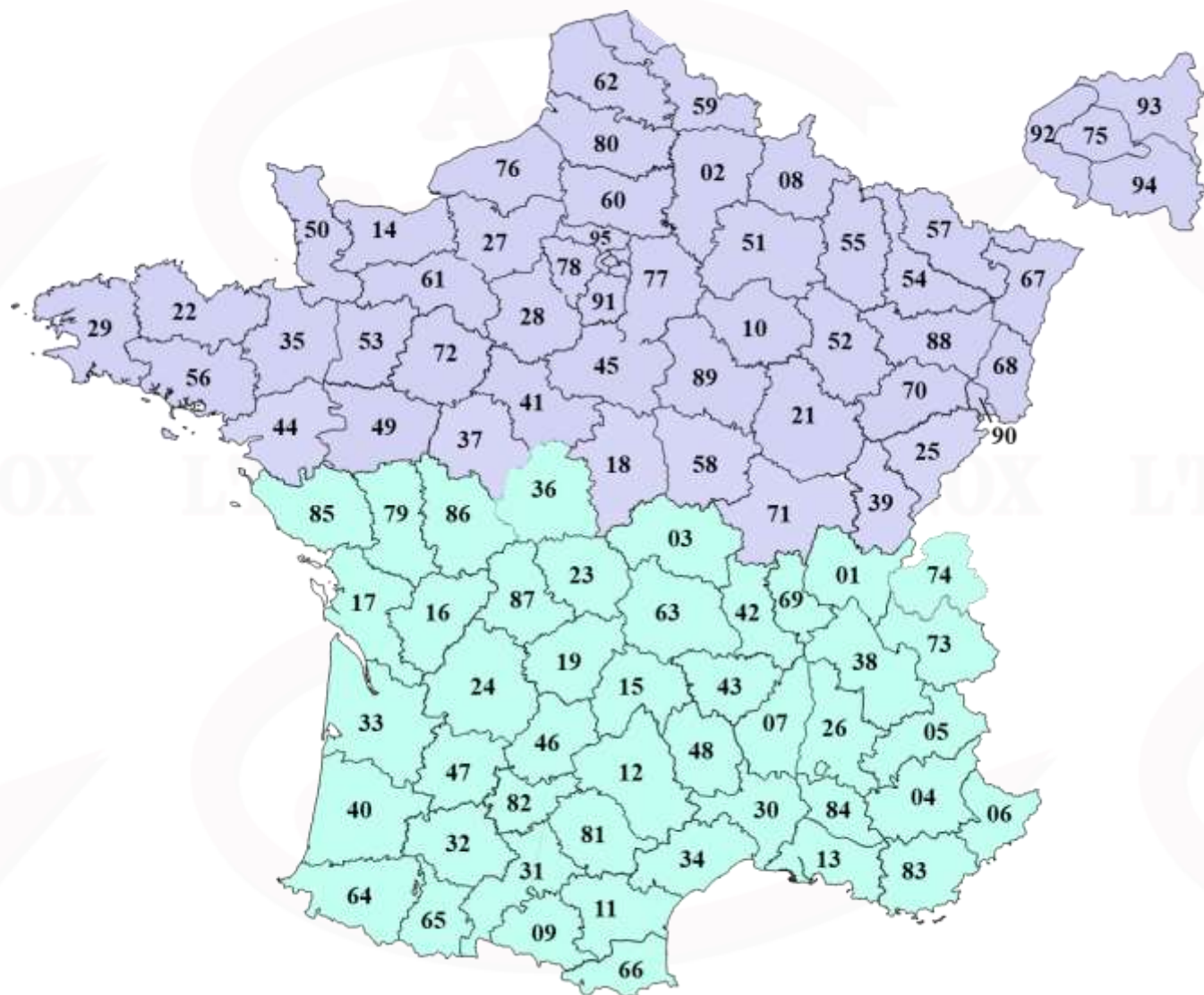

Mr PETIT Théo  
07.87.02.94.23.  
theo.petit@a-c-concept.com

Mr COLLIOT Aurélien  
06.77.74.46.22.  
aurelien.colliot@a-c-concept.com

Siège social  
47 Route des Aix 18220 RIANS  
02.48.64.85.77  
contact@a-c-concept.com



L'EXCELLENCE DE L'INOX



**AC-Concept SAS**, 47 route des Aix 18220 RIANS

Tél: 02 48 64 85 77 Fax: 02 48 64 87 56

Mail: [contact@a-c-concept.com](mailto:contact@a-c-concept.com)

SAS au capital de 125 000€

Siret: 51974679600027 Code APE: 3320 TVA: FR29519746796 RCS Bourges